

Swing Arm Assembly

Item	Part No.	Description	Item	Part No.	Description
1	8183151	5/16-18 x 0.75 SBHCS, Gr.8	24	85610655	Nut-Hex,Lck,Rvrs,3/8-16
2	8181771	Vertical Slide Knob	25	8183061	Duckhead Mount/Demount Tool Kit (Nylon)
3	8182028	Vertical Slide Spring	26	85607803	Roller Mount
	83031235	Vertical Slide Spring (Leverless)	27	85606462	Bead Roller (Duckhead) Pkg.
4	8182339	Swing Arm Shim Kit	28	8184432	Duckhead Mount/Demount Tool Kit (Grey)
5	8181038	Swing Arm Pivot Pin	29	8183055	3/8-16 x 0.750 SBHCS Screw
6	81828202	Swing Arm, for R.H. Cam Lock	30	85607820	Adjusting Lock Knob
	818282003	Swing Arm, Locking (Leverless)	31	85000317	5/16-18 x 1-1/2 HSWHCS Screw, Zinc
7	8100979	Handle Grip, Black Flex 3/4 I.D.	32	8107635	5/16" Plain Washer
8	8183673	Lock Handle/Lift Cam W/C, R.H.	33	85607814	Lock Assembly
9	8181095	1-5/8 Snap Ring	34	85607816	Lock Block
10	8182371	1-5/8 Dia. Wave Washer	35	70002301	1/2 x 3 Handle Grip
11	8181113	1/2"-13 Jam Nut, Gr. 5	36	85608961	Hybrid Duckhead Tail
12	85606343	Lock Plate	37	85608959	Hybrid Duckhead Mount/Demount Tool Lever Type
13	8181035	Lock Plate Lift Pin	**38	8184600	Manual Bead Depressor
14	8182812	Vertical Slide Shaft			
15	8182031	Rubber Bumper			
16	85606344	1/2 x 5/8 Shoulder Screw			
17	8182813	3/8-16 x 3/4" Ctr Bore Cap Scr, Gr.8			
18	8182027	7 ga. x .406 ID x 1.28 OD Washer			
19	8106302	3/8" Whiz Lock Screw, Gr.5			
20	8140667	1/4-20 x 1/4 Soc.Hd.Set Scr, Gr.8			
21	8182786	5MM x 25MM Dowel Pin			
22	8182787	0.562 Diameter x 0.515 LG. Roller			
23	81827881	Duckhead® Mount/Demount Tool Kit (Metal)			

**Accessory Item

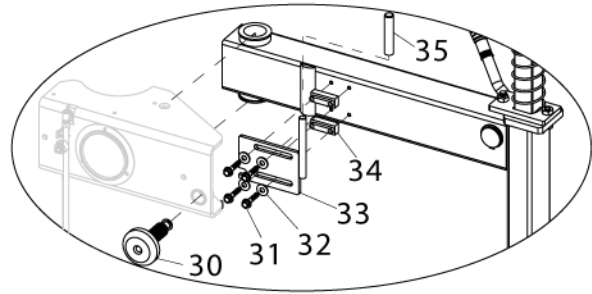
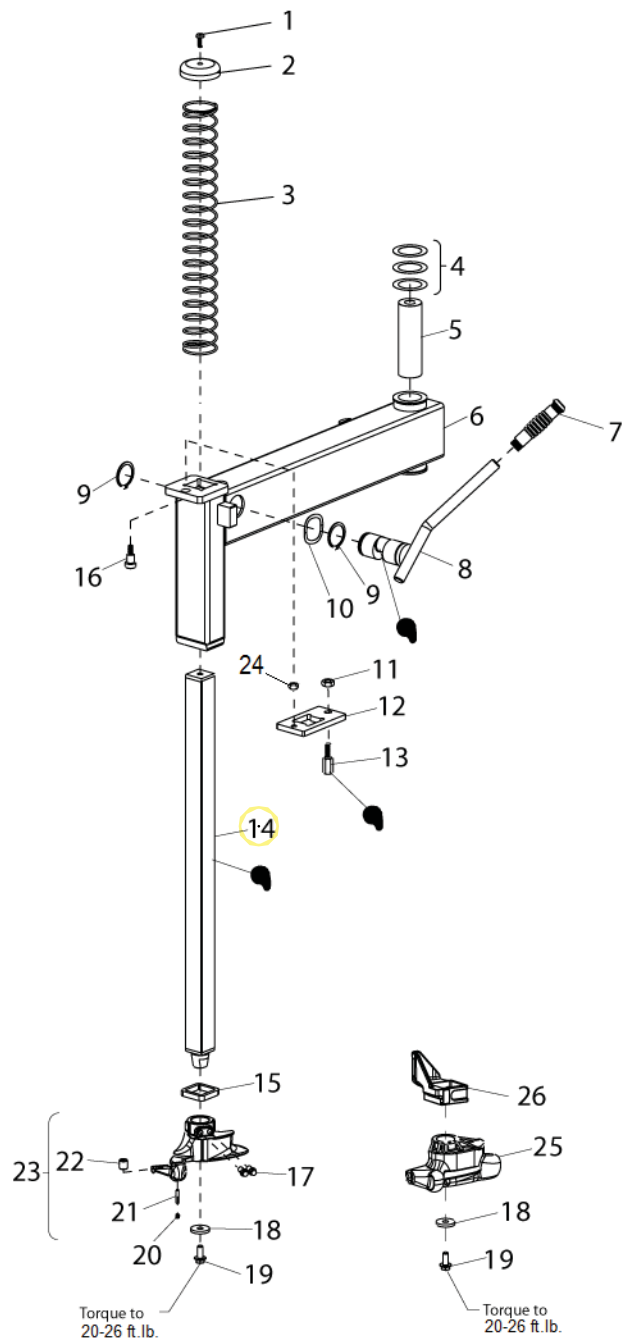

Swing Arm Locking Mechanism
(Leverless Unit)

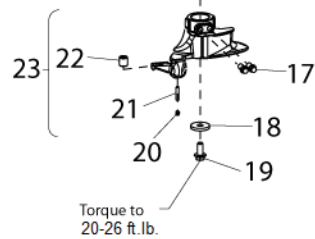

Steel
DuckHead®
Mount/Demount Tool

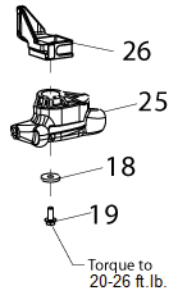

Nylon
DuckHead
Mount/Demount Tool

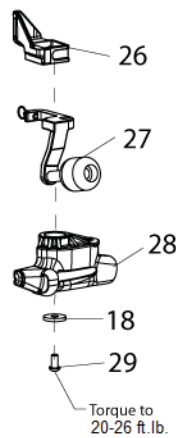

Grey
DuckHead
Mount/Demount Tool

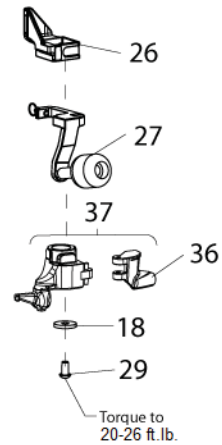

Hybrid
DuckHead
Mount/Demount Tool
Lever Type

● APPLY GREASE TO THESE LOCATIONS

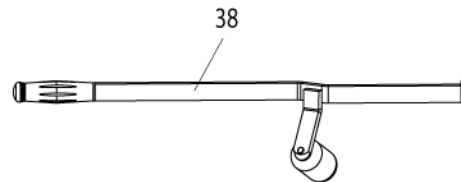

Manual Bead Depressor